

**NYC DEPARTMENT OF FINANCE
OFFICE OF THE CITY REGISTER**

This page is part of the instrument. The City Register will rely on the information provided by you on this page for purposes of indexing this instrument. The information on this page will control for indexing purposes in the event of any conflict with the rest of the document.

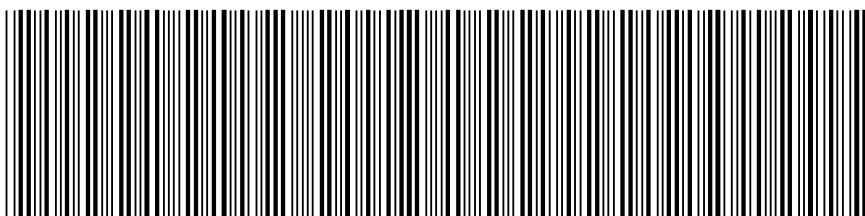

2006061302436001002EC5F8

RECORDING AND ENDORSEMENT COVER PAGE

PAGE 1 OF 2

Document ID: 2006061302436001

Document Date: 07-13-2006

Preparation Date: 07-13-2006

Document Type: **MAPS**

Document Page Count: 1

PRESENTER:

NYC DEPT. OF CITY PLANNING
TECHNICAL REVIEW DIVISION - 3W
22 READE STREET
NEW YORK, NY 10007-1216
212-720-3229
sgaglia@planning.nyc.gov

RETURN TO:

NYC DEPT. OF CITY PLANNING
TECHNICAL REVIEW DIVISION-3W
22 READE STREET
NEW YORK, NY 10007-1216
212-720-3229
sgaglia@planning.nyc.gov

PROPERTY DATA

| Borough | Block | Lot | Unit | Address |
|----------------------|-------|-----|------------|------------------------|
| BRONX | 2539 | 2 | Entire Lot | N/A MAJ WM DEEGAN BLVD |
| Property Type: OTHER | | | | |

CROSS REFERENCE DATA

CRFN _____ or Document ID _____ or _____ Year _____ Reel _____ Page _____ or File Number _____

PARTIES

PARTY 1:

NYC DEPT. OF CITY PLANNING
TECHNICAL REVIEW DIVISION-3W, 22 READE STREET
NEW YORK, NY 10007-1216

FEES AND TAXES

| | | | | |
|-------------------------------|----|------|--|--------|
| Mortgage | | | Recording Fee: | EXEMPT |
| Mortgage Amount: | \$ | 0.00 | Affidavit Fee: \$ | 0.00 |
| Taxable Mortgage Amount: | \$ | 0.00 | NYC Real Property Transfer Tax Filing Fee: | |
| Exemption: | | | \$ | 0.00 |
| TAXES: County (Basic): | \$ | 0.00 | NYS Real Estate Transfer Tax: | |
| City (Additional): | \$ | 0.00 | \$ | 0.00 |
| Spec (Additional): | \$ | 0.00 | | |
| TASF: | \$ | 0.00 | | |
| MTA: | \$ | 0.00 | | |
| NYCTA: | \$ | 0.00 | | |
| Additional MRT: | \$ | 0.00 | | |
| TOTAL: | \$ | 0.00 | | |

**RECORDED OR FILED IN THE OFFICE
OF THE CITY REGISTER OF THE
CITY OF NEW YORK**



Recorded/Filed 07-17-2006 11:44
City Register File No.(CRFN):
2006000403396

Annette McHill

City Register Official Signature

DEPARTMENT OF CITY PLANNING

CITY OF NEW YORK

Memorandum

TO: Office of the City Register
FROM: Department of City Planning
DATE: 7/13/2006
RE: Block & lot numbers for the ULURP mapping action(s) filed
for recordation on 7/13/2006

Record **Map No.** 13115 (For **ULURP No. C 060057 MMX**) against the
following tax lot(s):

Block: 2539 **Lot(s):** 2

This map change is in the matter of an application for an amendment to the City Map showing the establishment of a waterfront park between **Major Deegan Boulevard** and **The Harlem River**.

c: Tika Gurung - TRD
Irene Sadko - TRD
Yvette Gruel - Secretary, CPC
Daniel Donovan - BPX
Lorinda Morris - Law Department
File Folder - TRD

①

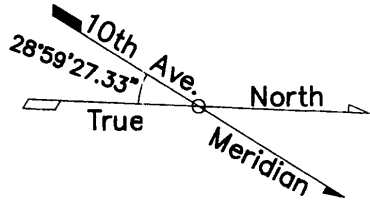

UNITED

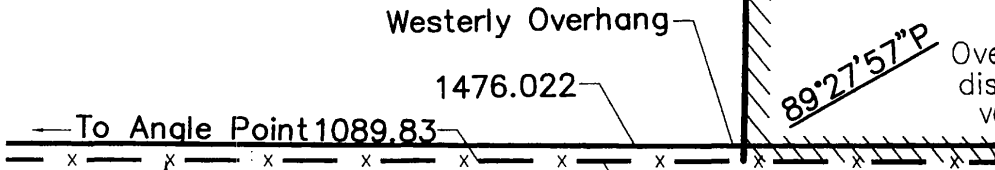
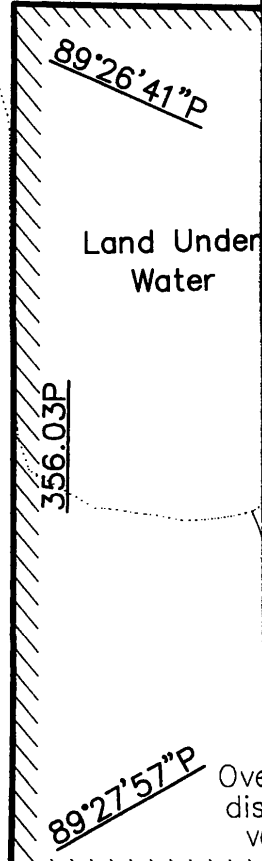
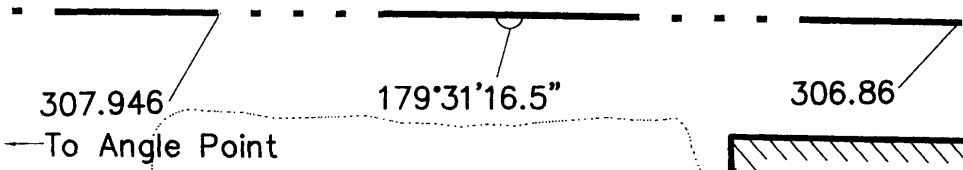

MAJOR

(SEE NOTE

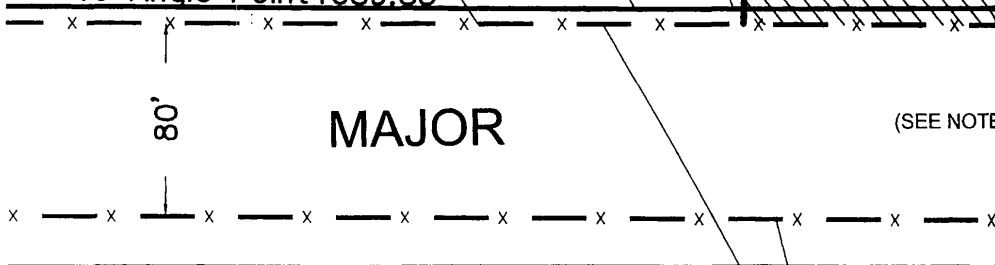

2

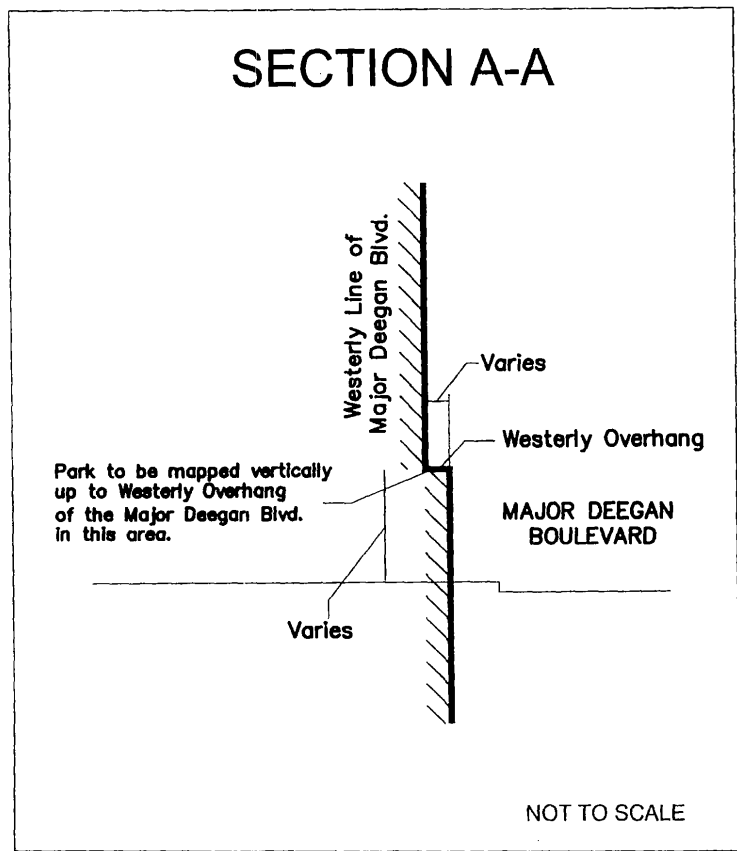
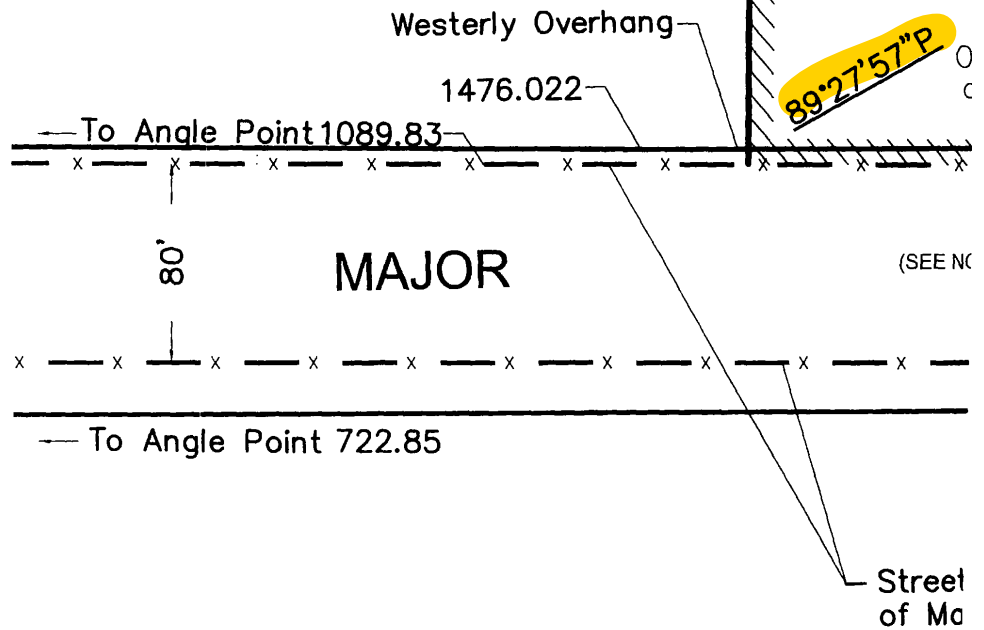

3

HARLEM

STATES PIERHEAD AND

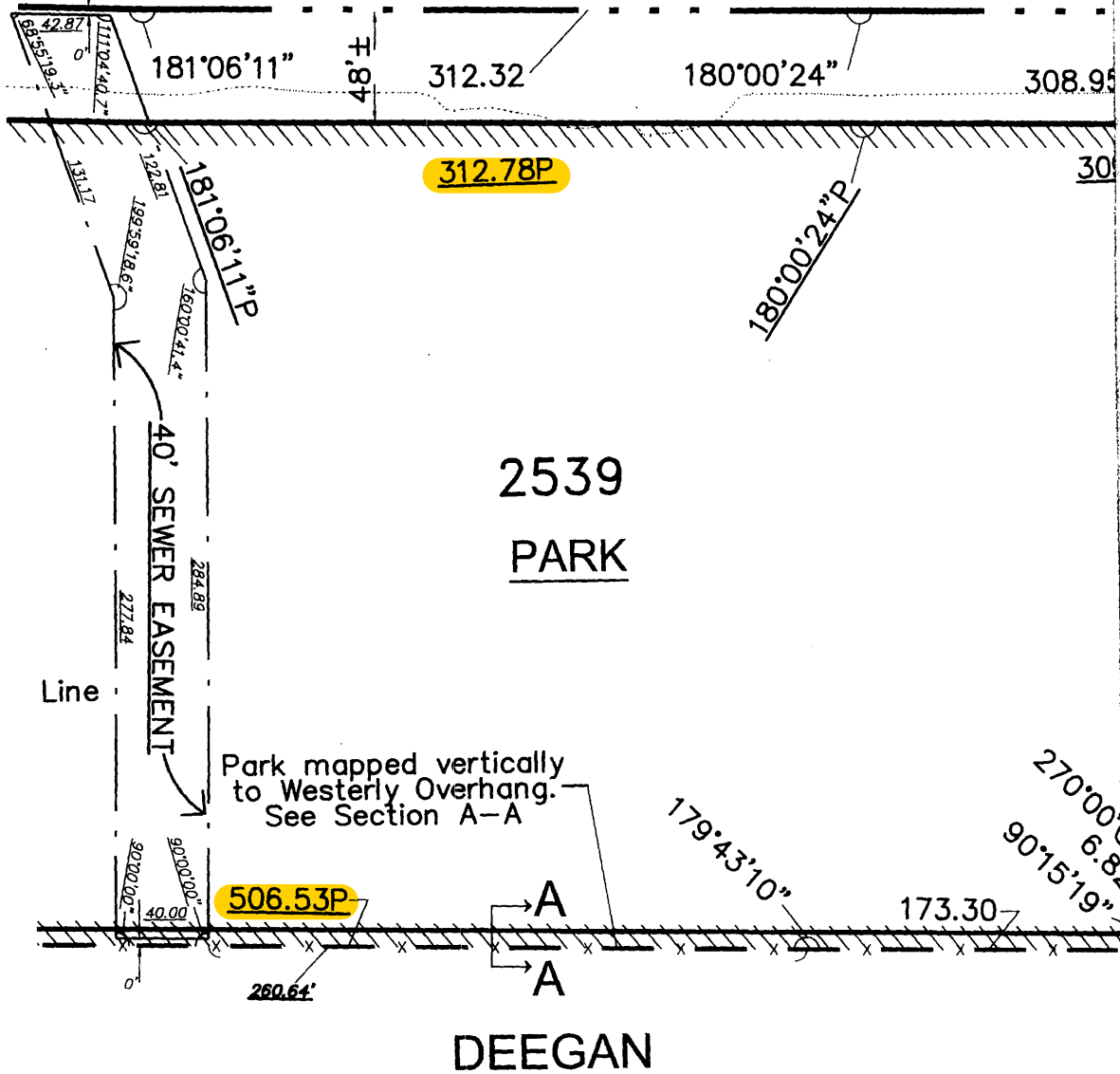

DEEGAN



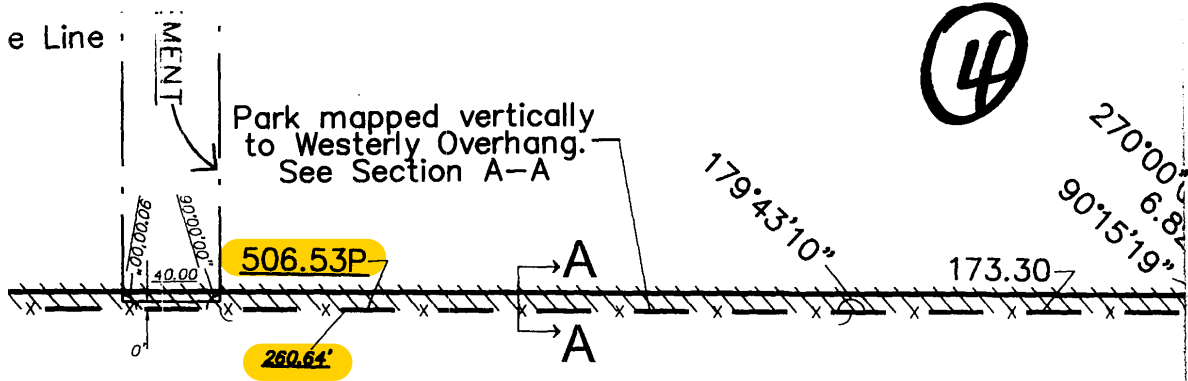



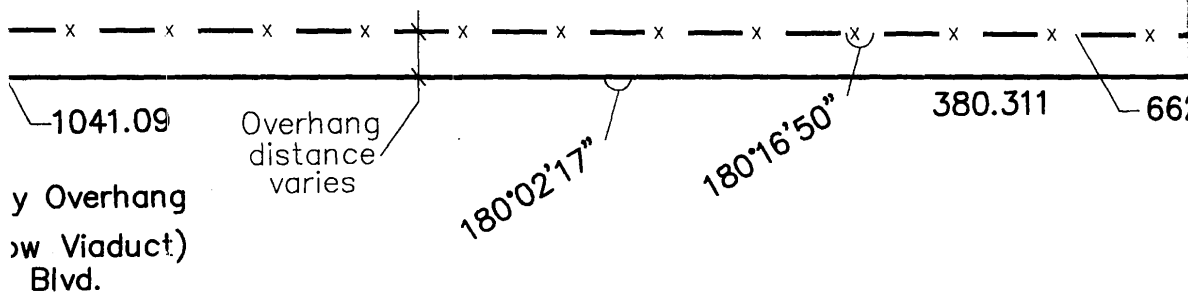

DEEGAN



Legend:

-  Indicates street line heretofore established and hereby retained.
-  Indicates street line below viaduct heretofore established and hereby retained.
-  Indicates United States Pierhead And Bulkhead Lines
-  Indicates sewer easement hereby established.
- 84.097 Indicates dimension heretofore established and hereby retained.
- 224.93P Indicates park dimension hereby established.
- 39.35 Indicates elevation heretofore established and hereby retained.
- 274.84 Indicates sewer easement dimension hereby established.
- 22.188' Indicates tie-in distance hereby established.
- 2539** Indicates block number.
-  Indicates park hereby established.

2539

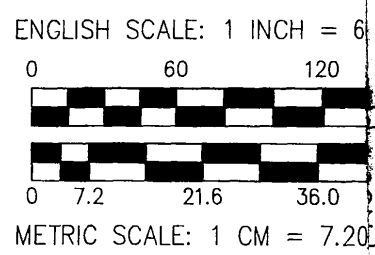

Record Map: Sections 7 & 8



0

ER

BULKHEAD

LINES

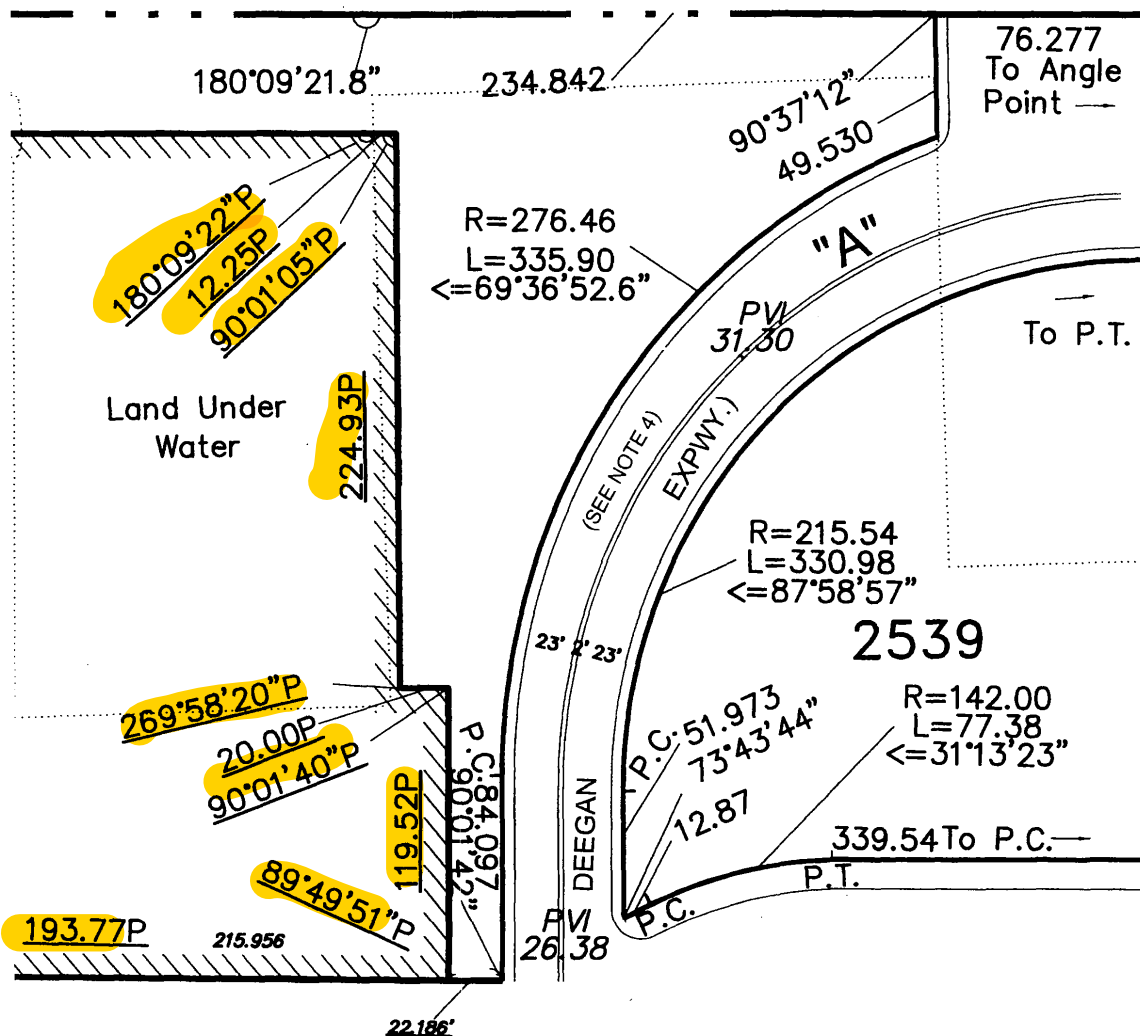

BLVD.



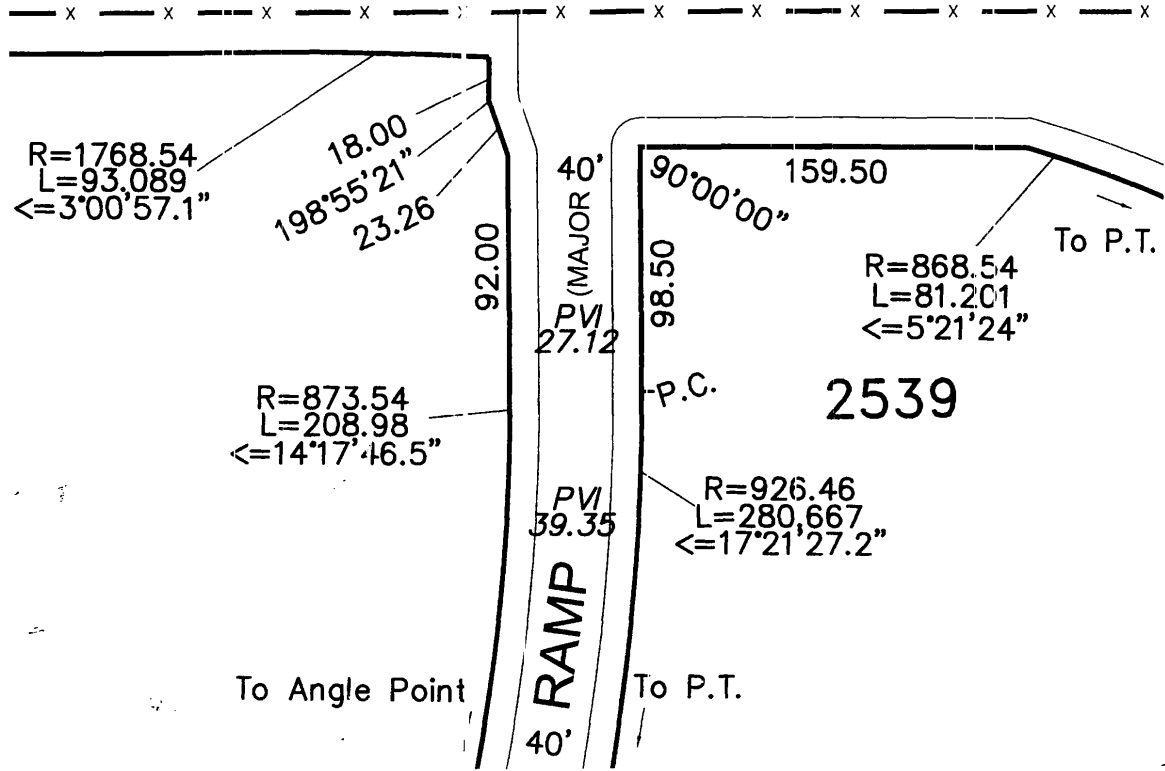
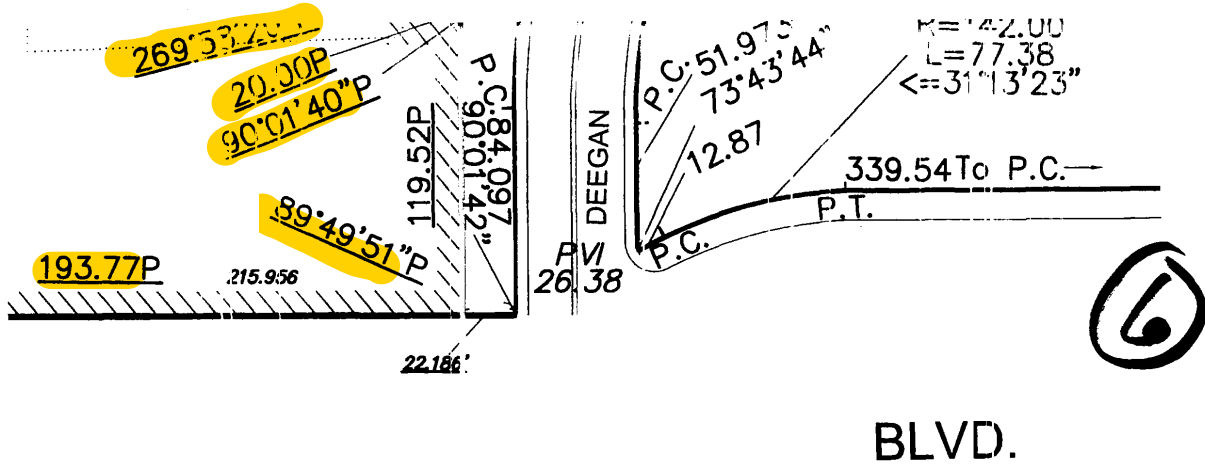

NOTE:

1. THE ELEVATIONS ON THIS MAP REFER TO THE DATUM OF THE E THE BRONX, 2.608 FEET ABOVE THE U.S. COAST AND GEODETIC SURFACE AND RELATIVE TO TOP OF CURB.
2. THIS PARK MAPPING IS SUBJECT TO SUBSURFACE EASEMENTS, WITHOUT LIMITATION, ANY STORM WATER MANAGEMENT EASEMENTS REQUESTED OR REQUIRED BY GOVERNMENTAL OR QUASI-GOVERNMENTAL AUTHORITIES, IN CONNECTION WITH DEVELOPMENT OF BLOCK 2356, LOT 20; BLOCK 2357, LOTS 1 AND 86; AND BLOCK 2358, LOTS 1 AND 86. THE METES AND BOUNDS DESCRIPTIONS AND DIMENSIONS OF SUCH EASEMENTS SHALL BE FURNISHED TO THE DEP OF PARKS AND RECREATION.
3. SIDEWALK DIMENSIONS AND TREATMENT LINES SHOWN ARE THE ESTABLISHED FOR GRADE DETERMINATION PURPOSES ONLY.
4. FOR GRADES IN MAJOR DEEGAN BLVD. AND RAMP "A" REFER TO DRAWINGS 11223 & 11923.



(.622 FEET)

V. GRUEL, SECRETARY OF THE CITY PLANNING COMMISSION, DO
 THAT THIS MAP IS ONE OF NINE SIMILAR MAPS APPROVED
 CITY PLANNING COMMISSION ON FEBRUARY 22, 2006 (CALENDAR NO. 8),
 SEQUENTLY APPROVED BY THE CITY COUNCIL ON APRIL 5, 2006
 (ACTION No. 242), WHICH ACTION COMPRISED THE FINAL APPROVAL AND
 THIS MAP WAS FILED ON THE DATE OF THIS CERTIFICATION AND WILL
 BE EFFECTIVE ON THE FOLLOWING DAY.

New York July 13, 2006

Vivian V. Gruel
 SECRETARY OF THE CITY PLANNING COMMISSION



NY 6200

32
 NY



© COPYRIGHT 2005, PRESIDENT OF THE BOROUGH OF THE BRONX

REFERENCE MAPS:

| | | | | | | |
|--|---|-------|---------|--------|------------|--------|
| City Planning Reference No.s: | C950177MMX | 22779 | CP17297 | CP4280 | C820341MMX | |
| PL. No. | 13072 | 11923 | 11645 | 11223 | 11223 | 11223B |
| A.M. | 348-8 | 337-5 | 327-3 | 269-3 | 269-2 | 274-3 |
| F.M. | 3203 | 3102 | 3010 | 2215 | 2214 | 2345 |
| D.M. | Not Applicable | | | | | |
| Bronx Borough President's Office Reference No.s: | Letter File: Record Map: Sections 7 & 8 | | | | | |

36

61 x